

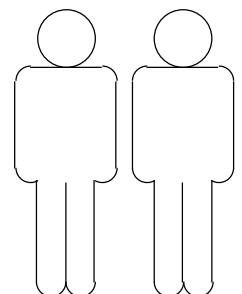

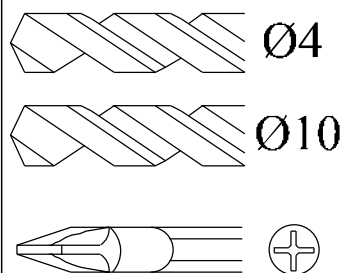

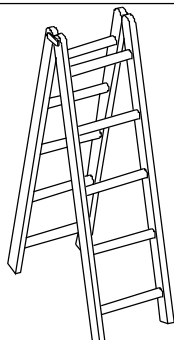

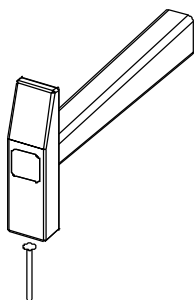

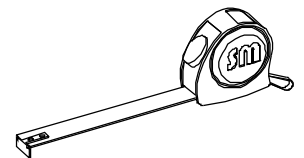
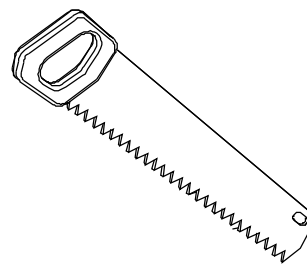
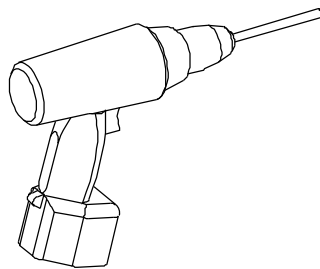
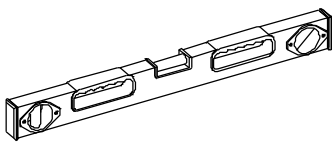

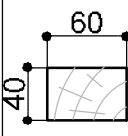
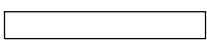
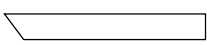
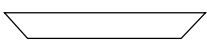
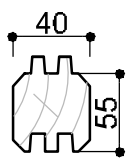

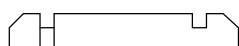
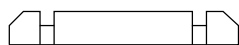
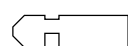
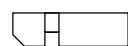

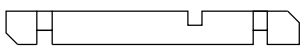
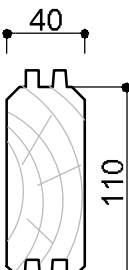
1/11  
→ || ← 40mm



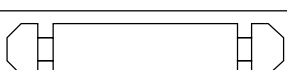

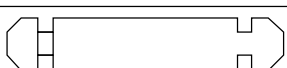

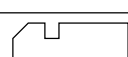
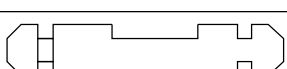
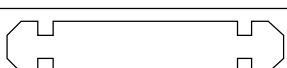

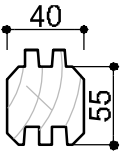

2,6 x 2,6

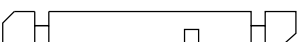
40021

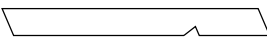
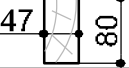
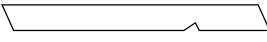
DE  
FR  
ENG

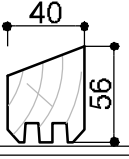
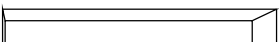

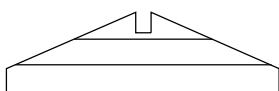
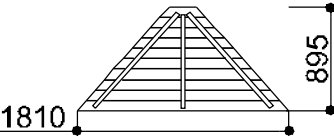
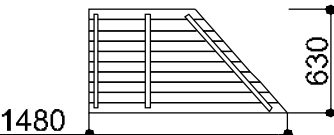
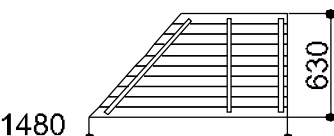
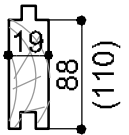
Dim.	Skizze, Sketch, Sketch	Pos.	Länge, Longueur, Length,mm	Quantity Quantität Quantité	Name, Nom, Name	Ref.
		①	2365	1	Fundamentbalken Lambourdes Foundation beam	283057
		②	2305	5	Fundamentbalken Lambourdes Foundation beam	283058
		③	1555	2	Fundamentbalken Lambourdes Foundation beam	283048
		④	1221	1	Fundamentbalken Lambourdes Foundation beam	283050
		⑥	280	1	Front Brett Madrier avant Front board	400195
		⑦	1740	1	Seiten Brett Madrier latéral Side board	400187
		⑧	2600	1	Zurück Brett Madrier arrière Back board	400185
		⑱	280	1	Front Brett Madrier avant Front board	400198
		⑳	505	1	Seiten Brett Madrier latéral Side board	400191
		㉑	505	1	Seiten Brett Madrier latéral Side board	400192
		㉕	2600	1	Seiten Brett Madrier latéral Side board	400193
		⑨	280	17	Front Brett Madrier avant Front board	400197
		⑰	280	17	Front Brett Madrier avant Front board	400196
		⑩	1740	5	Seiten Brett Madrier latéral Side board	400180
		⑪	2600	37	Zurück Brett Madrier arrière Back board	400184
		⑫	505	25	Seiten Brett Madrier latéral Side board	400182
		⑬	1740	4	Seiten Brett Madrier latéral Side board	400188
		⑭	505	12	Seiten Brett Madrier latéral Side board	400190
		⑮	505	13	Seiten Brett Madrier latéral Side board	400181
		⑯	1740	1	Seiten Brett Madrier latéral Side board	400189
		⑲	1415	1	Front Brett Madrier avant Front board	400199
		㉓	2600	1	Seiten Brett Madrier latéral Side board	400183





		22	2600	1	Zurück Brett Madrier arrière Back board	400186
		24	1415	1	Front Brett Madrier avant Front board	400200
		26	2600	1	Seiten Brett Madrier latéral Side board	400194
		28	2105	4	Sparren Panne faitière Rafters	404071
		27	1530	4	Sparren Panne faitière Rafters	404072
		29		1	Verbindungen Composé Rafters join	286991
		30	1200	4	Top Brett Madrier haut Top board	401028
		31	1200	4	Top Brett Madrier haut Top board	401029
		32	1364	1	Wandpanel Panneau de mur Wall panel	402021
		33	1810 x895	4	Dachplatte Panneau de toit Roof panel	284607
		35	1480 x630	4	Dachplatte Panneau de toit Roof panel	284613
		34	1480 x630	4	Dachplatte Panneau de toit Roof panel	284612
		38	2340	27 (22)	Boden Bretter Plancher bois Floor board	283525

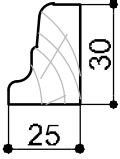
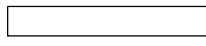
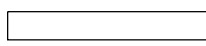
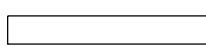

4 / 11  
→ || ← 40mm

SPEZIFIKATION  
SPÉCIFICATION  
SPECIFICATION

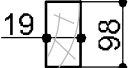
2,6 x 2,6

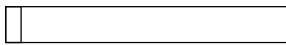
40021

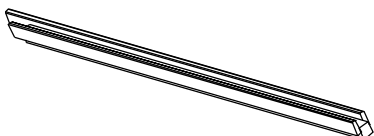
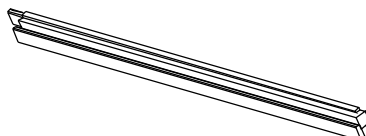
		39	1540	1	Bodenleiste Plancher latte Baseboard	283233
		40	2380	2	Bodenleiste Plancher latte Baseboard	283226
		41	1540	1	Bodenleiste Plancher latte Baseboard	283233
		42	600	1	Bodenleiste Plancher latte Baseboard	283268
43						
		44	1550	4	Wind Brett Planche de rive Wind board	285019
		45	1550	4	Wind Brett Planche de rive Wind board	285018

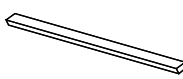
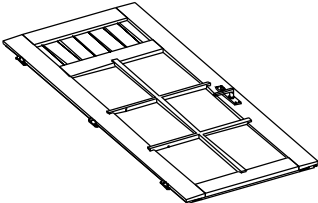
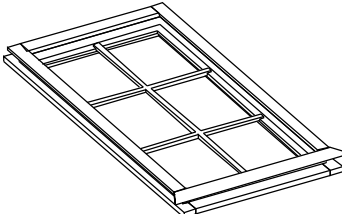
	TR1	1973	1	Türrahmen links Cadre de porte gauche Door frame left	409212
	TR2	1973	1	Türrahmen rechts Cadre de porte droite Door frame right	409225
	TR3	945	1	Über Türrahmen Montant supérieur Door frame top	409229
	TR4	745	1	Türstufe Latte de finition bas Door frame bottom	409230
	T1	765x 1850	1	Tür Porte Doors	289012
	F	850x 1530	2	Fenster Fenêtre Window	409109

Alle maßen ca +/-3% / les dimensions des pièces peuvent évoluer +/- 3% / size tolerance +/- 3%

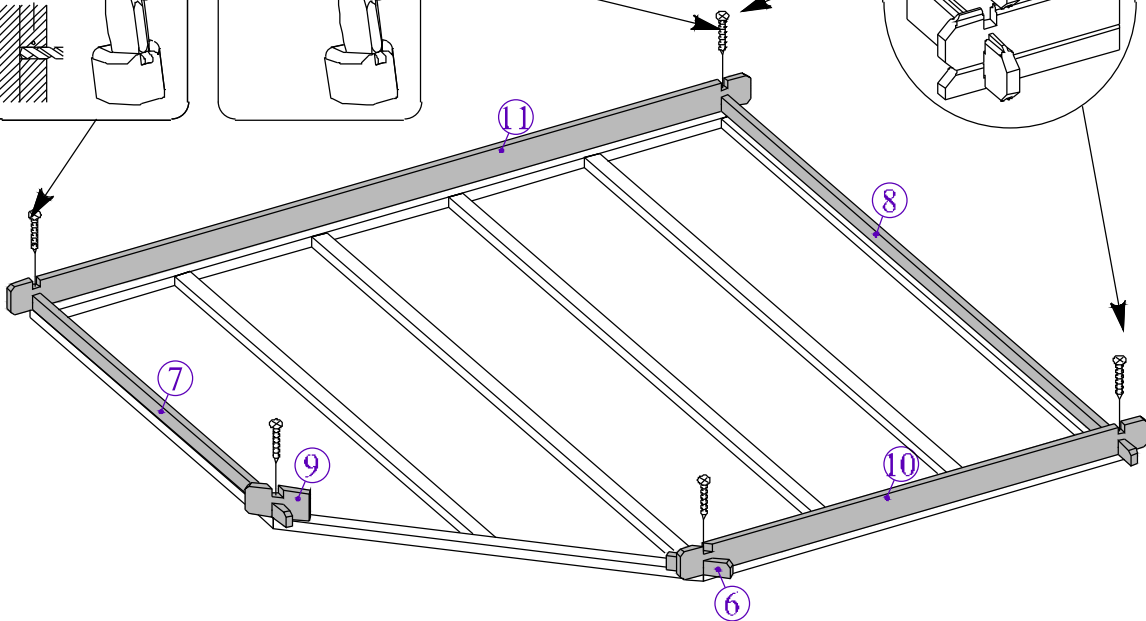
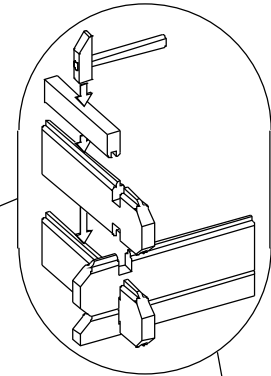
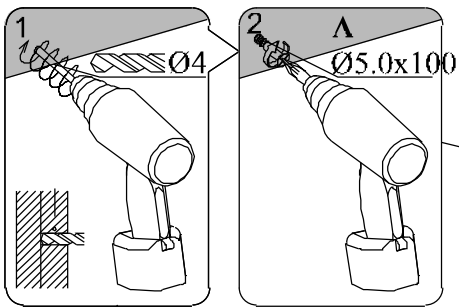
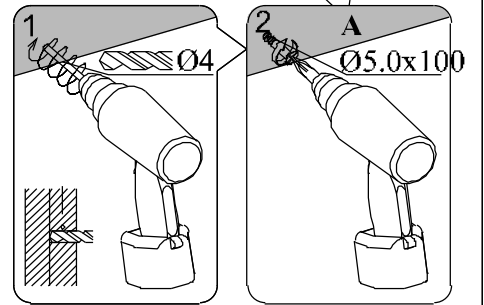
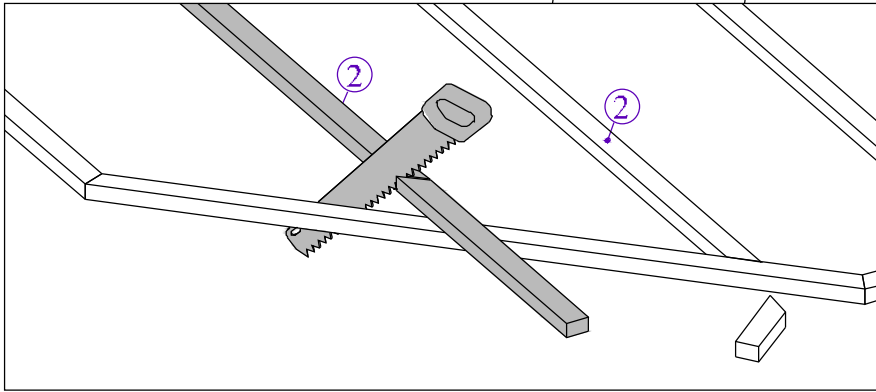
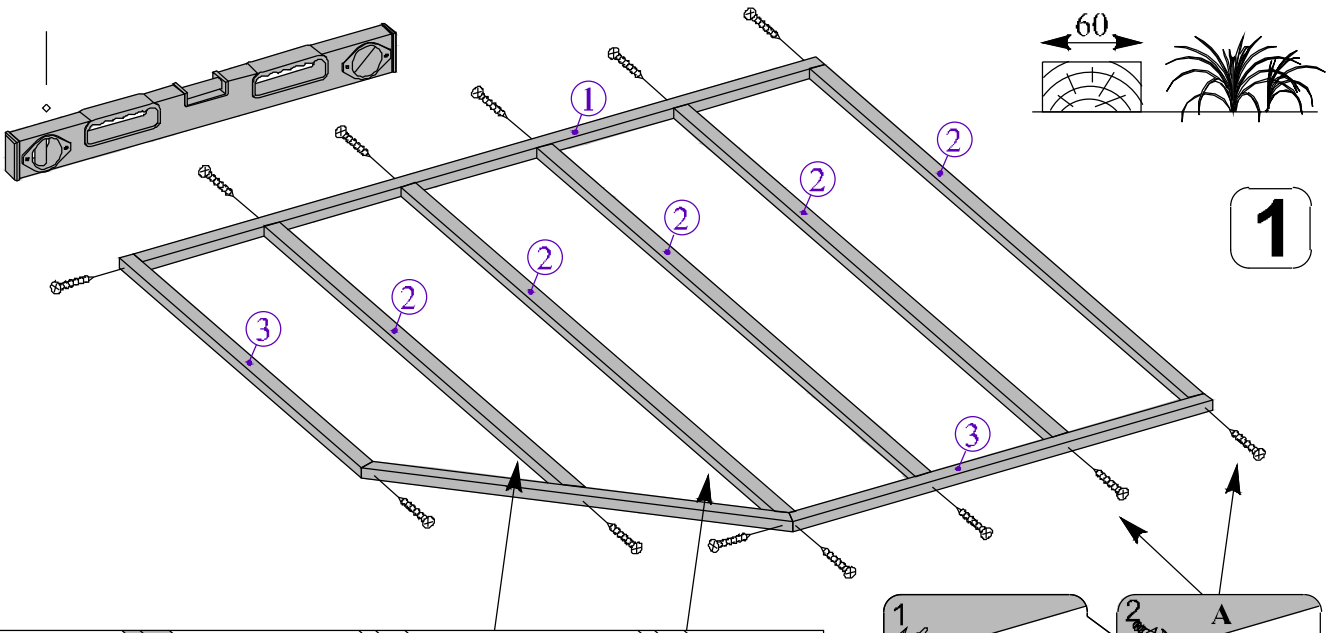

3

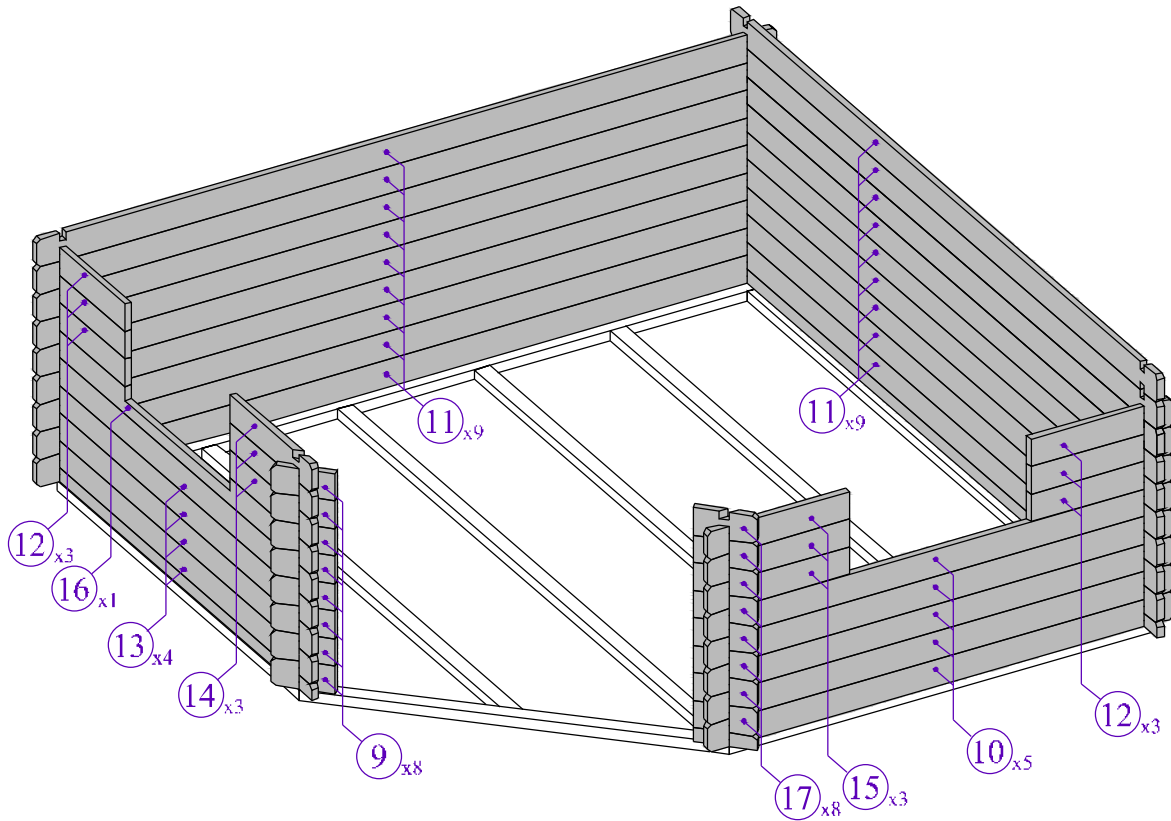

4

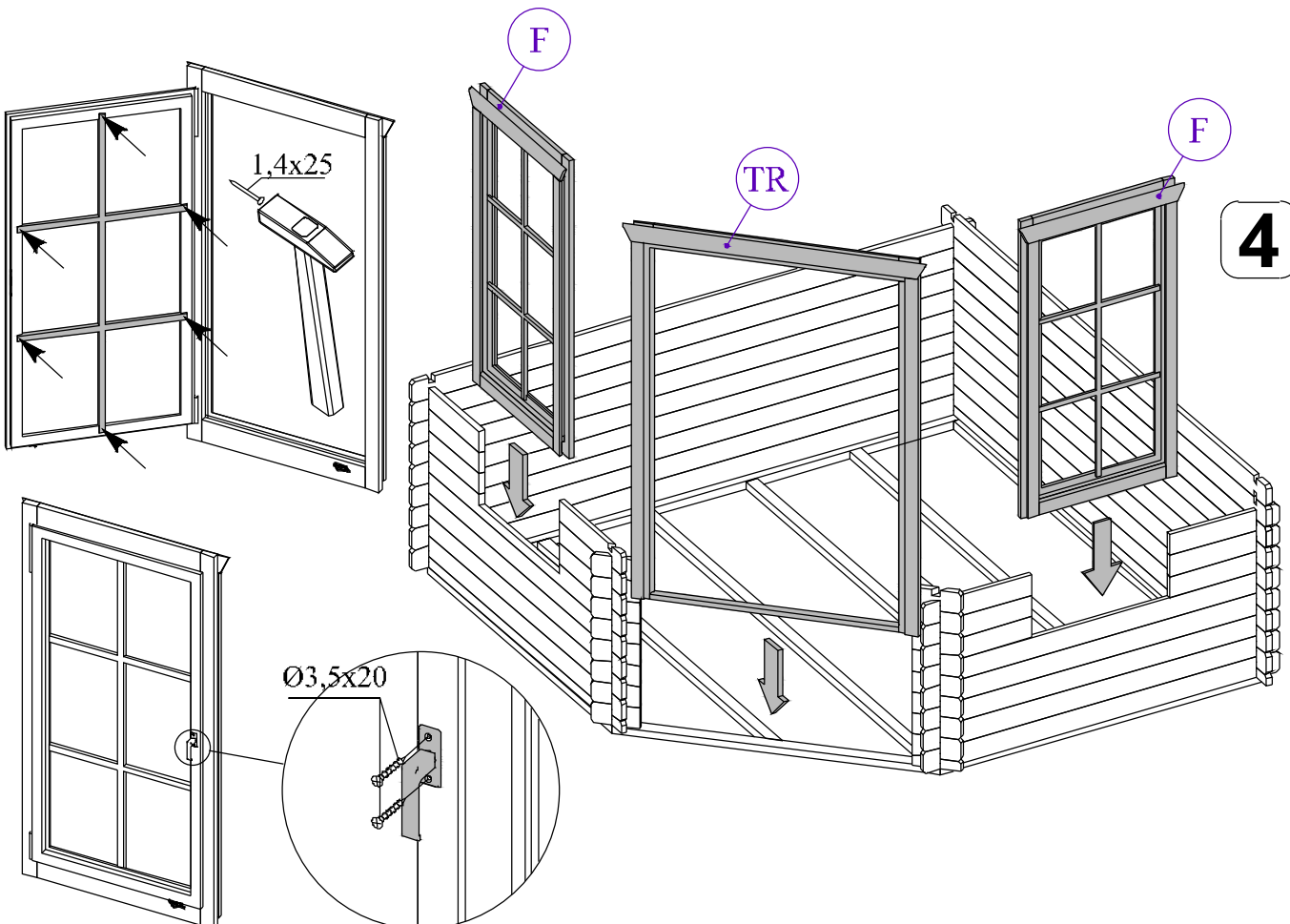

7/11  
→||←40mm

2,6 x 2,6

40021

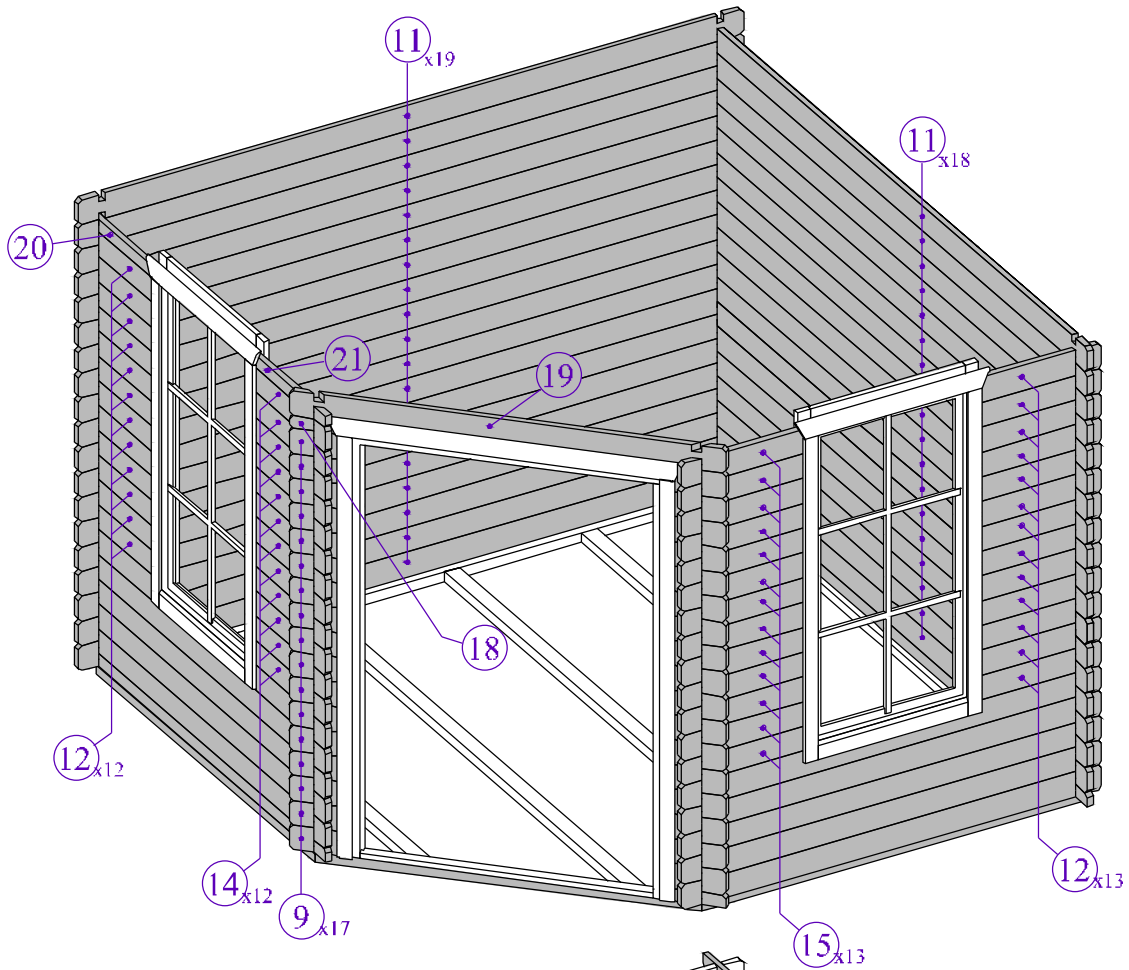

5

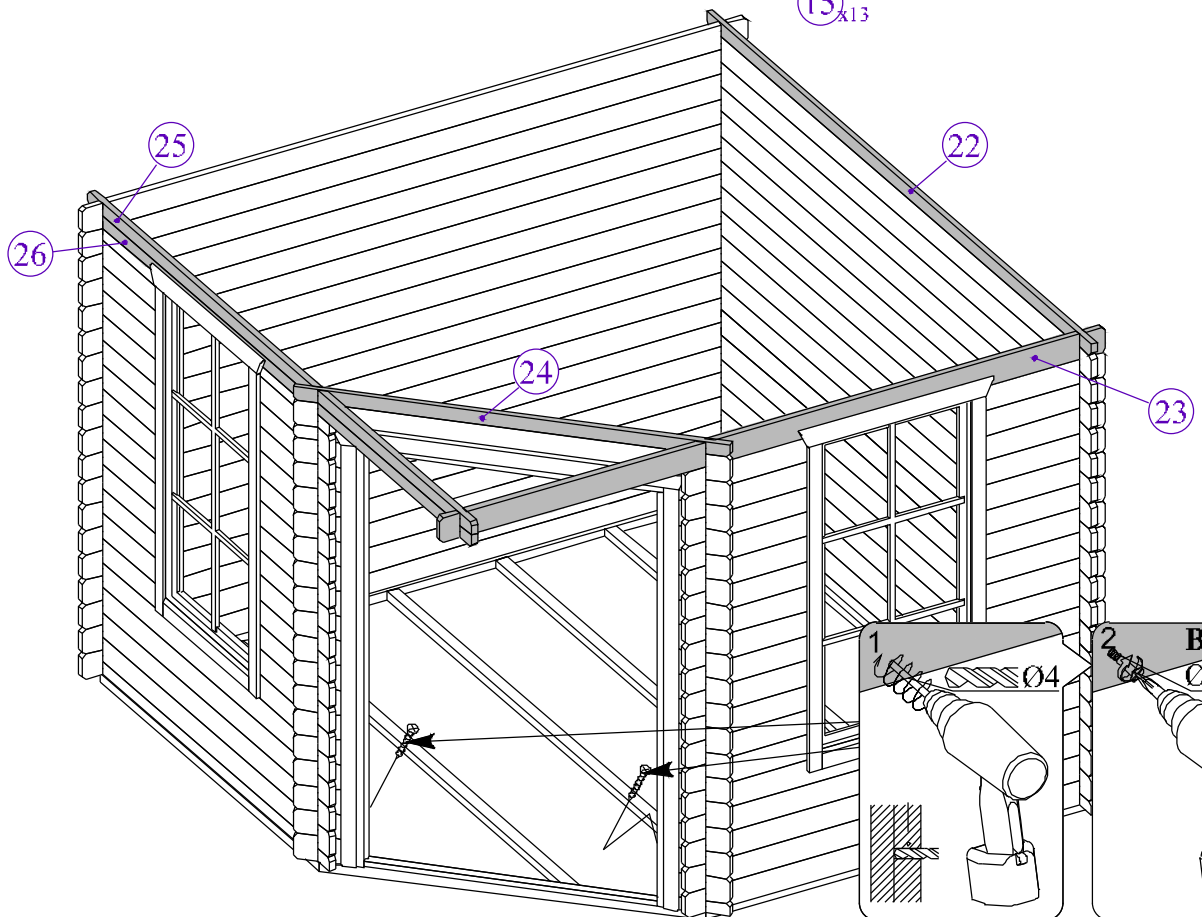

6

8 / 11  
→ || ← 40mm

2,6 x 2,6

40021

7

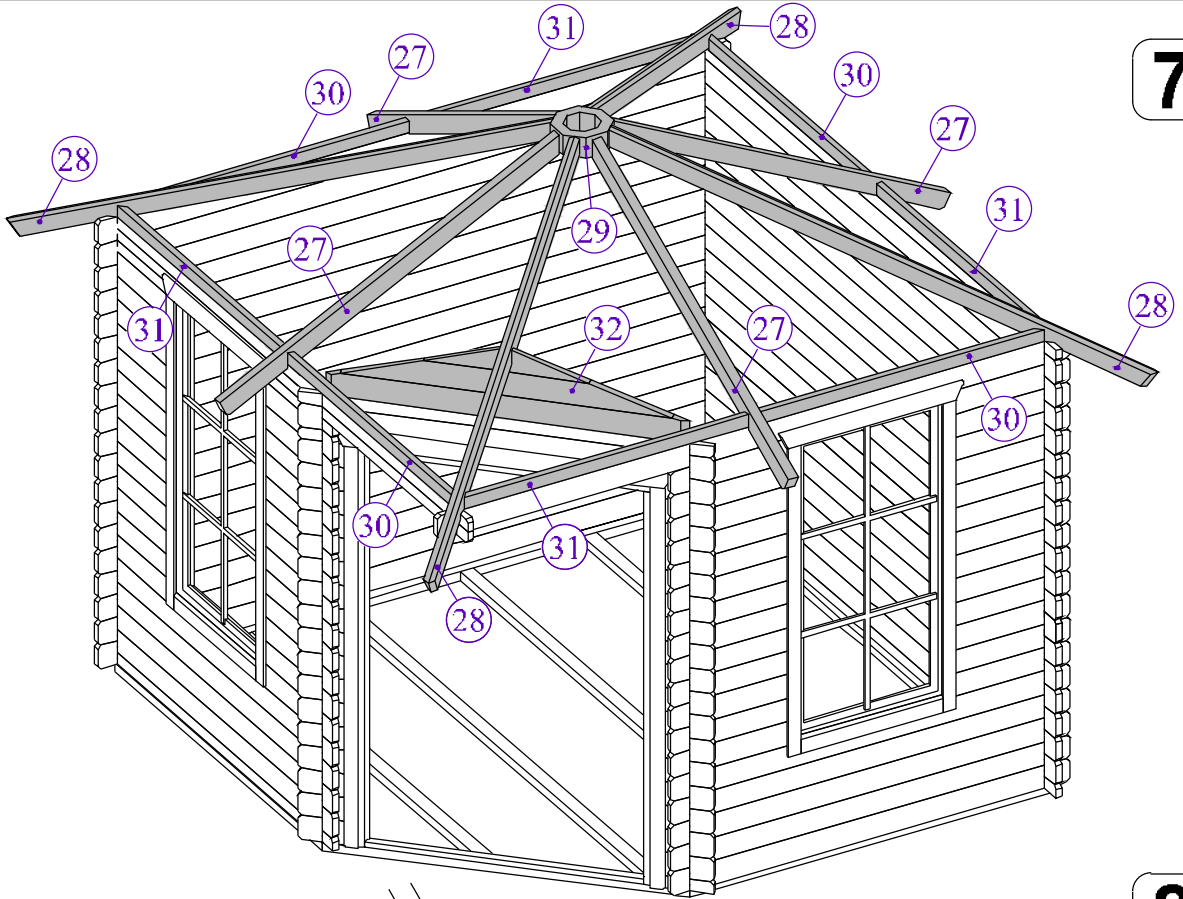

8

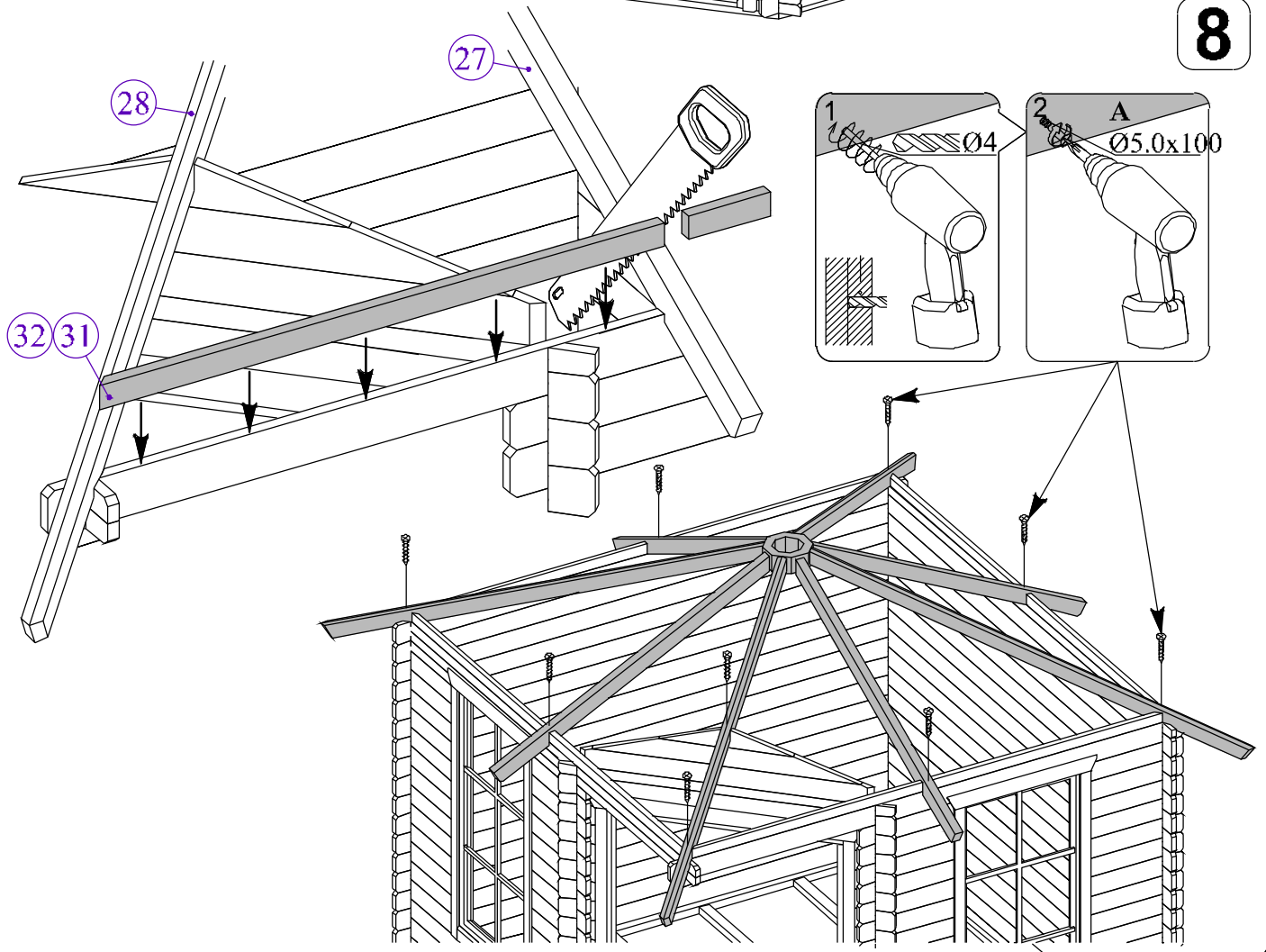



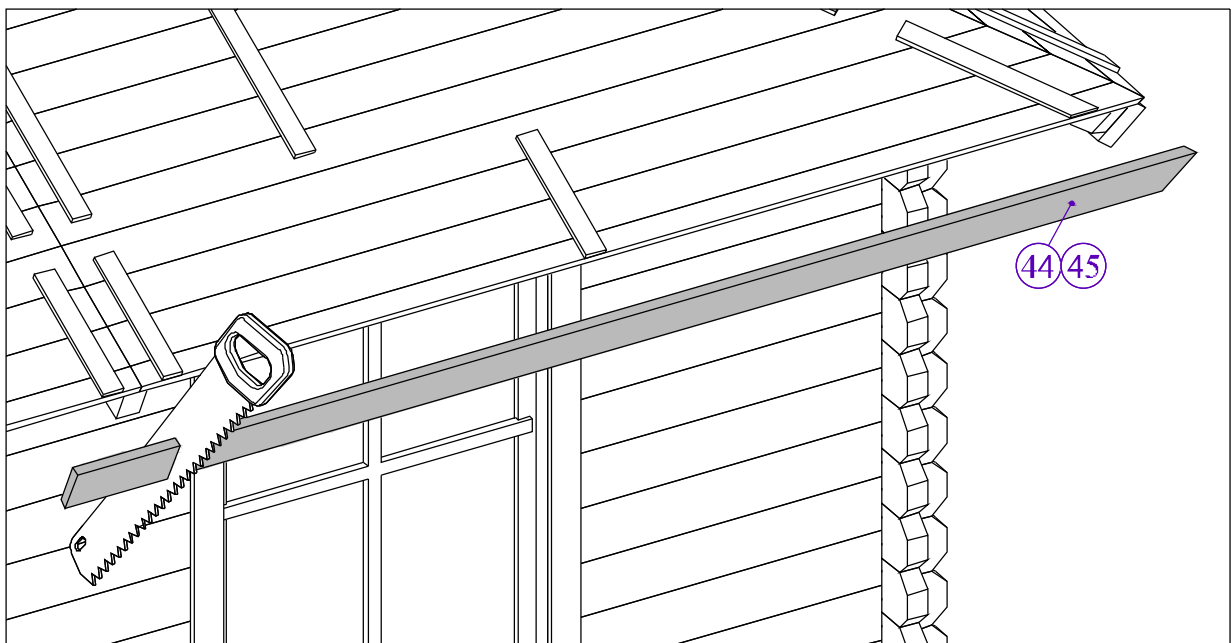
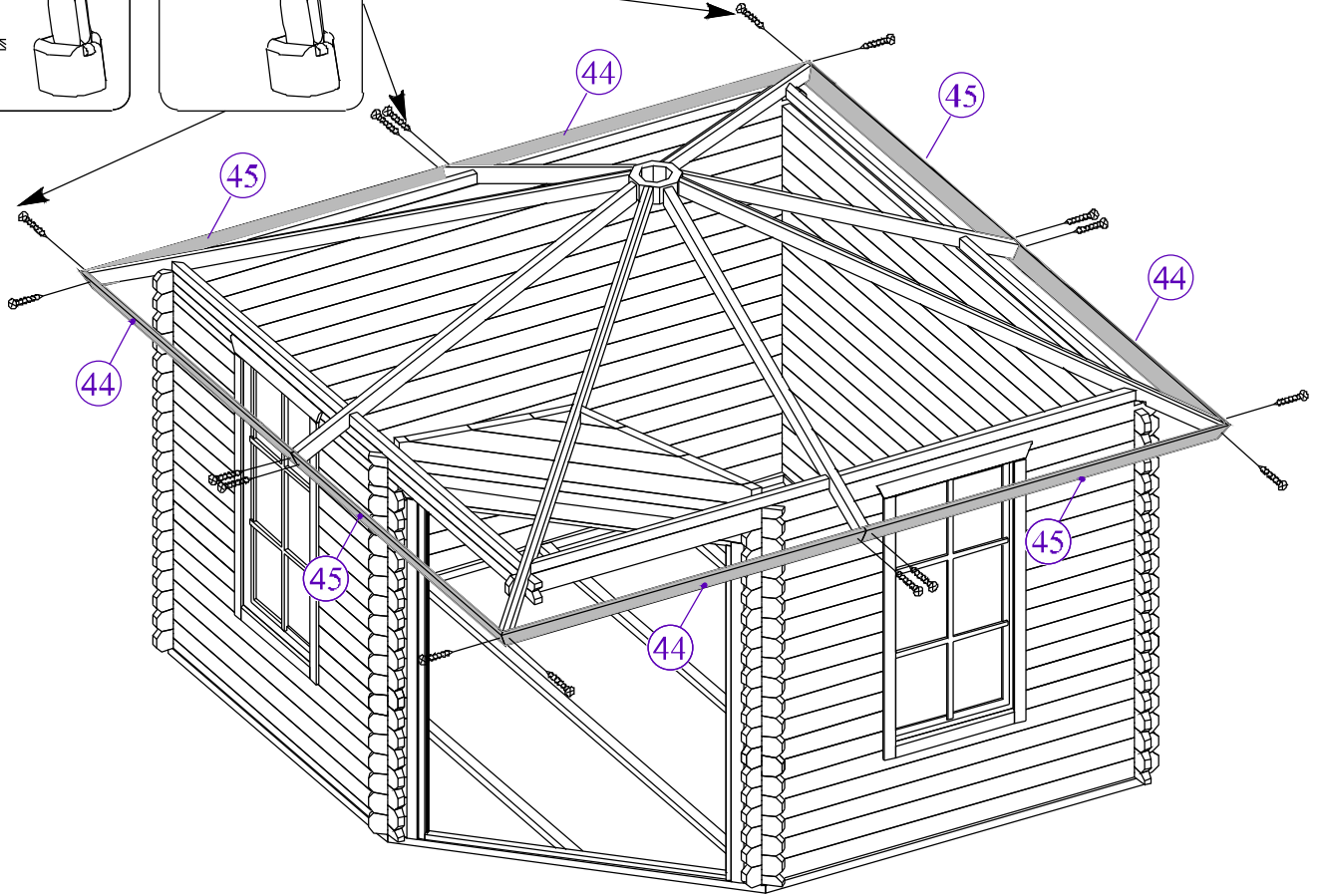
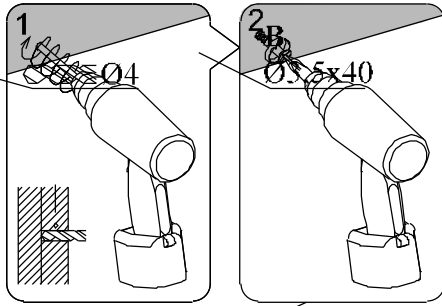

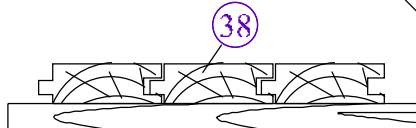
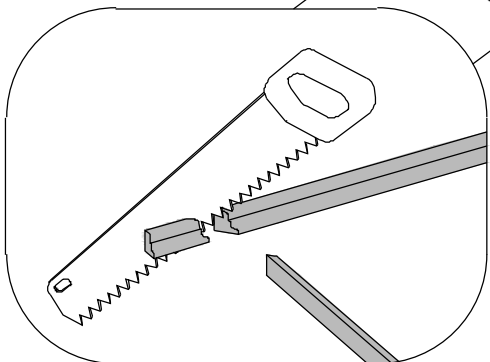
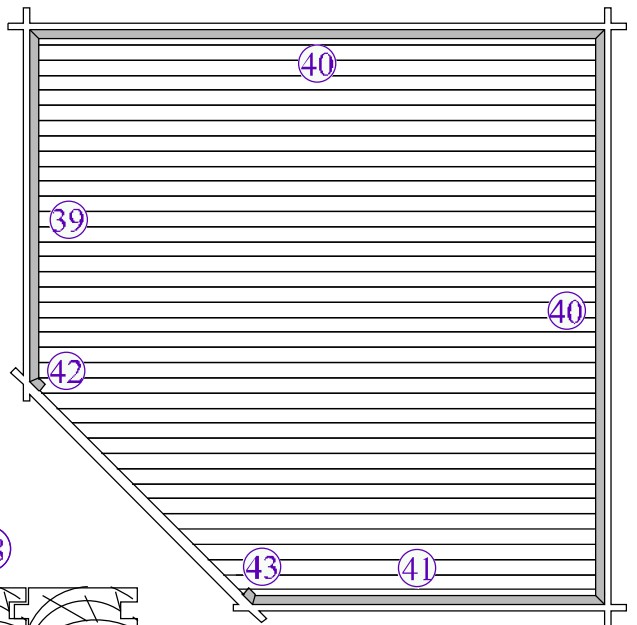
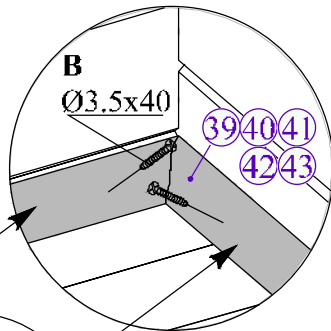
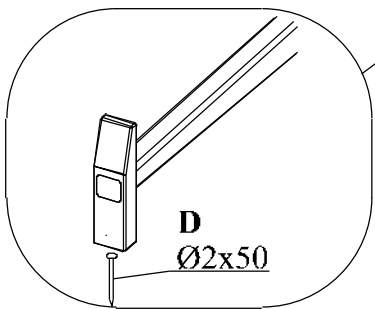
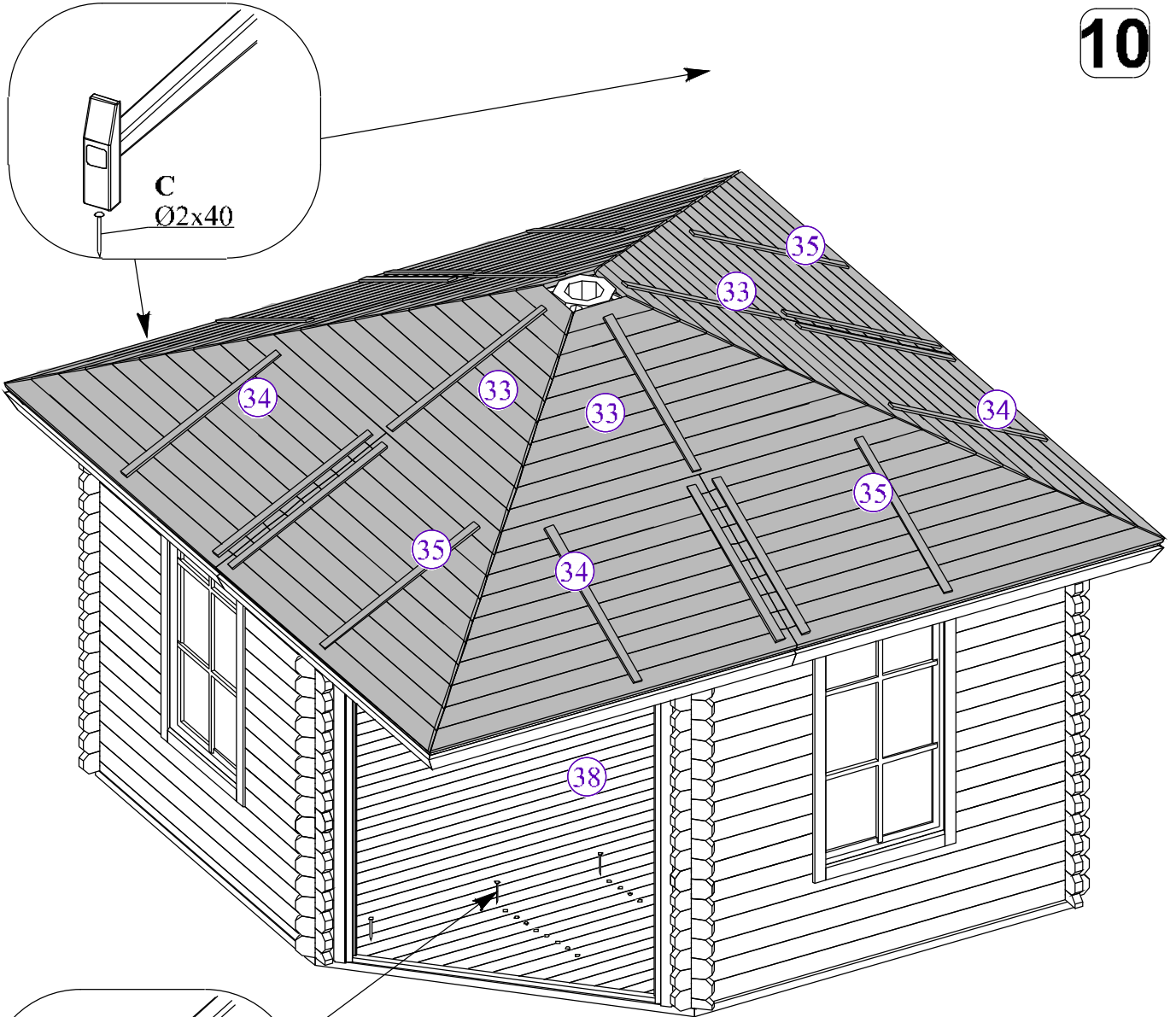

11 / 11  
→ || ← 40mm

2,6 x 2,6

40021

